

STM32

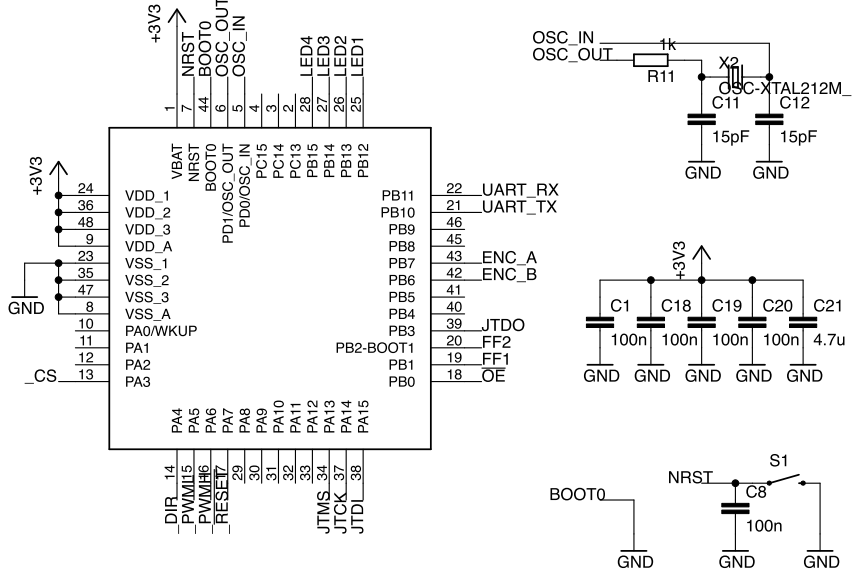

STATUS LEDs

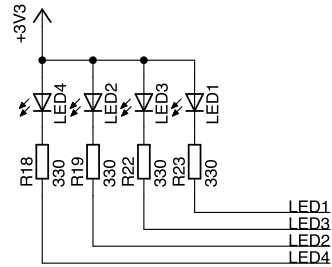

ENCODER CONNECTOR

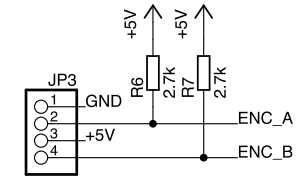

JTAG INTERFACE

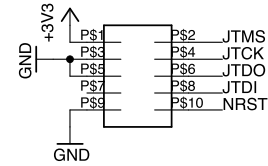

LEVEL SHIFTER

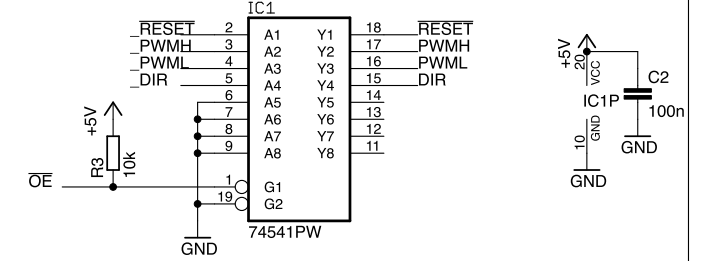

POWER SUPPLY

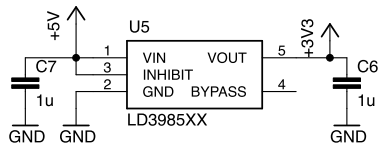

POWER + SERIAL CONNECTOR

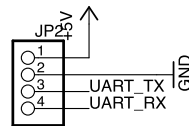

CURRENT SENSE LEVEL SHIFTER

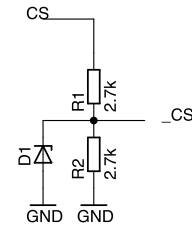

POLOLU CONNECTOR

